

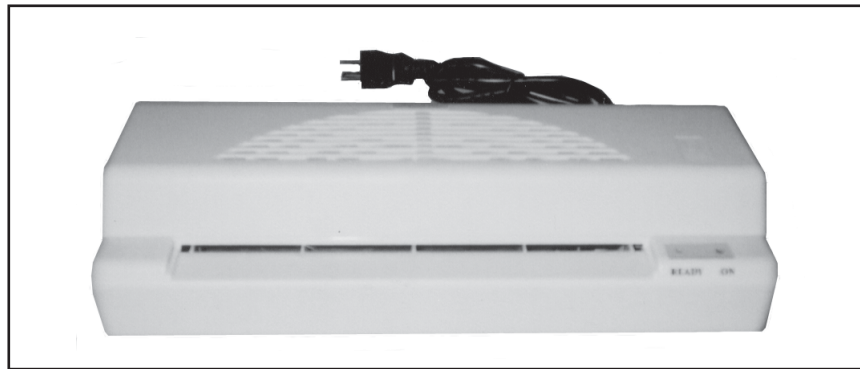

9" HOT LAMINATOR

Model 92499

OPERATING INSTRUCTIONS



3491 Mission Oaks Blvd., Camarillo, CA 93011
Visit our Web site at: <http://www.harborfreight.com>

**TO PREVENT SERIOUS INJURY,
READ AND UNDERSTAND ALL WARNINGS
AND INSTRUCTIONS BEFORE USE.**

Copyright© 2004 by Harbor Freight Tools®. All rights reserved. No portion of this manual or any artwork contained herein may be reproduced in any shape or form without the express written consent of Harbor Freight Tools.

For technical questions or replacement parts, please call 1-800-444-3353.

PRODUCT SPECIFICATIONS

| | |
|----------------------------|--|
| Electrical Requirements | 110 Volt, 60 Hz, 2 Amps Red LED "Power" Indicator Green LED "Ready" Indicator Motor Type: Synchronous Power Plug Type: 2 Prong |
| Circuit Protection | Internal 3.15 Amp Fuse (for replacement by qualified technician only) |
| Maximum Laminating Width | 9" |
| Maximum Document Thickness | .024" (.6mm) |
| Film Thickness | 0.0030"-0.0040" |
| Laminating Speed | Approx. 12" Per Minute |
| Warm Up Time | 7 to 8 Minutes |
| Maximum Temperature | 300° Fahrenheit |
| Overall Dimensions | 13-1/4" L x 5-1/4" W x 3-1/8" H |
| Weight | 3.5 Pounds |

UNPACKING

When unpacking, check to make sure all the parts shown on the **Parts List** on **page 11** are included. If any parts are missing or broken, please call Harbor Freight Tools at the number shown on the cover of this manual as soon as possible.

SAVE THIS MANUAL

You will need this manual for the safety warnings and precautions, assembly, operating, inspection, maintenance and cleaning procedures, parts list and assembly diagram. Keep your invoice with this manual. Write the invoice number on the inside of the front cover. Keep this manual and invoice in a safe and dry place for future reference.

GENERAL SAFETY RULES

IMPORTANT SAFETY INSTRUCTIONS



READ AND UNDERSTAND ALL INSTRUCTIONS
Failure to follow all instructions listed in the following pages may result in electric shock, fire, and/or serious injury.

SAVE THESE INSTRUCTIONS

REV 07/05;09/05

WORK AREA

1. **Keep your work area clean and well lit.** Cluttered benches and dark areas invite accidents. Keep the work area well lit. Always keep the work area free of obstructions, grease, oil, trash, and other debris.
2. **Do not operate the Laminator in explosive atmospheres, such as in the presence of flammable liquids, gases, or dust.** Electrical equipment creates sparks which may ignite flammables.
3. **Keep bystanders, children, and visitors away while operating laminating equipment.** Distractions can cause you to lose control. Protect others in the work area from accidents.

PERSONAL SAFETY

1. **Stay alert. Watch what you are doing, and use common sense when operating a Laminator. Do not use laminating equipment while tired or under the influence of drugs, alcohol, or medication.** A moment of inattention while operating laminating equipment may result in personal injury.
2. **Dress properly. Do not wear loose clothing or jewelry. Contain long hair. Keep your hair, clothing, and gloves away from the Laminator.** Loose clothes, jewelry, or long hair can become caught in the Laminator, causing personal injury.
3. **Avoid accidental starting. Be sure the Power Switch is off before plugging in.** Plugging in laminating equipment with the Power Switch on invites accidents.
4. **Do not overreach. Keep proper footing and balance at all times.** Proper footing and balance enables better control of the Laminator in unexpected situations.
5. **Use eye and skin protection.** Always wear ANSI approved safety goggles. Wear fire resistant work gloves to protect from accidental burns.

TOOL USE AND CARE

1. **Do not force the laminating equipment. Use the correct equipment for your application.** The correct equipment will do the job better and safer at the rate for which it is designed.

2. **Do not use the Laminator if the Power Switch does not turn it on or off.** Any equipment that cannot be controlled with the Power Switch is dangerous and must be replaced.
3. **Disconnect the Power Cord Plug from its electrical outlet before making any adjustments, changing accessories, or storing the Laminator.** Such preventive safety measures reduce the risk of starting the equipment accidentally.
4. **Make sure the Laminator has completely cooled before touching it and storing it.**
5. **Store idle laminating equipment out of reach of children and other untrained persons.** Laminating equipment is dangerous in the hands of untrained users.
6. **Maintain laminating equipment with care.** Do not use damaged equipment. Tag damaged equipment “Do not use” until repaired.
7. **Check for misalignment or binding of moving parts, breakage of parts, and any other condition that may affect operation of the Laminator. If damaged, have the equipment serviced before using.** Many accidents are caused by poorly maintained equipment.
8. **Use only accessories that are recommended by the manufacturer for your model.** Accessories that may be suitable for one brand of Laminator may become hazardous when used on another brand.

SERVICE

1. **Equipment service must be performed only by qualified repair personnel.** Service or maintenance performed by unqualified personnel could result in a risk of personal injury.
2. **When servicing equipment, use only identical replacement parts. Follow instructions in the “*Inspection, Maintenance, And Cleaning*” section of this manual.** Use of unauthorized parts or failure to follow maintenance instructions may create a risk of electric shock and personal injury.

ELECTRICAL SAFETY

1. **Grounded tools must be plugged into an outlet properly installed and grounded in accordance with all codes and ordinances. Never remove the**

grounding prong or modify the plug in any way. Do not use any adapter plugs. Check with a qualified electrician if you are in doubt as to whether the outlet is properly grounded. If the tools should electrically malfunction or break down, grounding provides a low resistance path to carry electricity away from the user.

2. **Avoid body contact with grounded surfaces such as pipes, radiators, ranges, and refrigerators.** There is an increased risk of electric shock if your body is grounded.
3. **Do not expose laminating equipment to rain or wet conditions.** Water entering electrically powered equipment will increase the risk of electric shock. The Laminator is intended for indoor use only.
4. **Do not abuse the Power Cord. Never use the Power Cord to carry the Laminator or pull the Plug from an outlet. Keep the Power Cord away from heat, oil, sharp edges, or moving parts. Replace damaged Power Cords immediately.** Damaged Power Cords increase the risk of electric shock.

GROUNDING

WARNING!

Improperly connecting the grounding wire can result in the risk of electric shock. Check with a qualified electrician if you are in doubt as to whether the outlet is properly grounded. Do not modify the power cord plug provided with the tool. Never remove the grounding prong from the plug. Do not use the tool if the power cord or plug is damaged. If damaged, have it repaired by a service facility before use. If the plug will not fit the outlet, have a proper outlet installed by a qualified electrician.

GROUNDING TOOLS: TOOLS WITH THREE PRONG PLUGS

1. Tools marked with “Grounding Required” have a three wire cord and three prong grounding plug. The plug must be connected to a properly grounded outlet. If the tool should electrically malfunction or break down, grounding provides a low resistance path to carry electricity away from the user, reducing the risk of electric shock. **(See Figure A, next page.)**
2. The grounding prong in the plug is connected through the green wire inside the cord to the grounding system in the tool. The green wire in the cord must be the only wire connected to the tool’s grounding system and must never be attached to an electrically “live” terminal. **(See Figure A.)**

- Your tool must be plugged into an appropriate outlet, properly installed and grounded in accordance with all codes and ordinances. The plug and outlet should look like that in the following illustration. (See Figure A.)

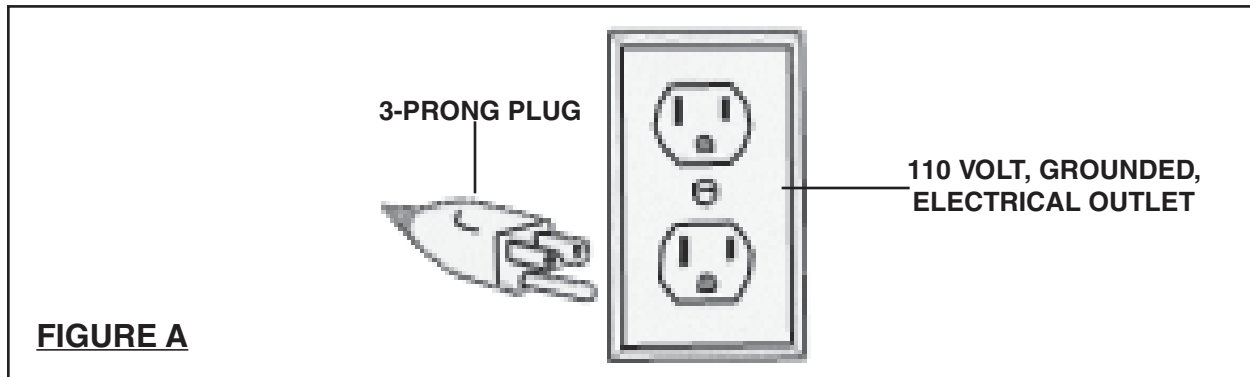

EXTENSION CORDS

- Grounded** tools require a three wire extension cord.
- As the distance from the supply outlet increases, you must use a heavier gauge extension cord. Using extension cords with inadequately sized wire causes a serious drop in voltage, resulting in loss of power and possible tool damage. (See Figure B.)
- The smaller the gauge number of the wire, the greater the capacity of the cord. For example, a 14 gauge cord can carry a higher current than a 16 gauge cord. (See Figure B.)

| RECOMMENDED MINIMUM WIRE GAUGE FOR EXTENSION CORDS* (110 VOLT) | | | | | |
|---|-----------------------|------------|------------|-------------|-------------|
| NAMEPLATE AMPERES (At Full Load) | EXTENSION CORD LENGTH | | | | |
| | 25 FEET | 50 FEET | 75 FEET | 100 FEET | 150 FEET |
| 0-2.0 | 18 | 18 | 18 | 18 | 16 |
| 2.1-3.4 | 18 | 18 | 18 | 16 | 14 |
| 3.5-5.0 | 18 | 18 | 16 | 14 | 12 |
| 5.1-7.0 | 18 | 16 | 14 | 12 | 12 |
| 7.1-12.0 | 16 | 14 | 12 | 10 | - |
| 12.1-16.0 | 14 | 12 | 10 | - | - |
| 16.1-20.0 | 12 | 10 | - | - | - |

*Based on limiting the line voltage drop to five volts at 150% of the rated amperes.

FIGURE B

4. When using more than one extension cord to make up the total length, make sure each cord contains at least the minimum wire size required.
(See Figure B.)
5. If you are using one extension cord for more than one tool, add the nameplate amperes and use the sum to determine the required minimum cord size.
(See Figure B.)
6. If you are using an extension cord outdoors, make sure it is marked with the suffix “W-A” (“W” in Canada) to indicate it is acceptable for outdoor use.
7. Make sure your extension cord is properly wired and in good electrical condition. Always replace a damaged extension cord or have it repaired by a qualified electrician before using it.
8. Protect your extension cords from sharp objects, excessive heat, and damp or wet areas.

SYMBOLOLOGY





| | |
|---|--------------------------------------|
|  | Double Insulated |
|  | Canadian Standards Association |
|  | Underwriters Laboratories, Inc. |
| V ~ | Volts Alternating Current |
| A | Amperes |
| no xxxx/min. | No Load Revolutions Per Minute (RPM) |

FIGURE C

SPECIFIC SAFETY RULES

1. **Maintain labels and nameplates on the Laminator.** These carry important information. If unreadable or missing, contact Harbor Freight Tools for a replacement.
2. **Always place the Laminator on a dry, flat, level, sturdy non flammable work surface capable of supporting the weight of the Laminator and any additional accessories. Make sure to place the Laminator in a location that is out of reach of children.**

3. **Never place objects on top of the Laminator.** Always check to make sure the Cooling Vents on top of the Laminator are not obstructed.
4. **Turn off the Laminator and unplug it from its electrical outlet before removing any jammed paper or film.**
5. **The laminating Film (not included) must always be approximately 1/4" longer and wider than the objects being laminated.**
6. **Use a larger size laminating Film if there is no proper size Film available.** After laminating, cut off the excess laminating Film.
7. **To avoid jams, always insert the sealed side of the laminating Film first into the Laminator.**
8. **Prior to using the Laminator, make sure to read and understand the instructions and safety warnings as outlined in the manufacturer of the laminating Film. NEVER attempt to laminate flammable or corrosive objects.**
9. **Never leave the Laminator unattended when it is plugged into an electrical outlet.** Make sure to unplug it from its electrical outlet before leaving the area.
10. **Performance of this Laminator may vary depending on variations in local line voltage.** Extension cord usage may also affect equipment performance.
11.  **WARNING!** The warnings, precautions, and instructions discussed in this instruction manual cannot cover all possible conditions and situations that may occur. It must be understood by the operator that common sense and caution are factors which cannot be built into this product, but must be supplied by the operator.

SAVE THESE INSTRUCTIONS

OPERATING INSTRUCTIONS

NOTE: For additional information regarding the parts listed in the following pages, refer to the **Assembly Diagram** on **page 11**.

1. Extend the two Pull Out Rear Platforms (6). **(See Figure D.)**
2. Plug the Power Cord (2) into the nearest 110 volt, grounded, electrical outlet. **(See Figure D.)**

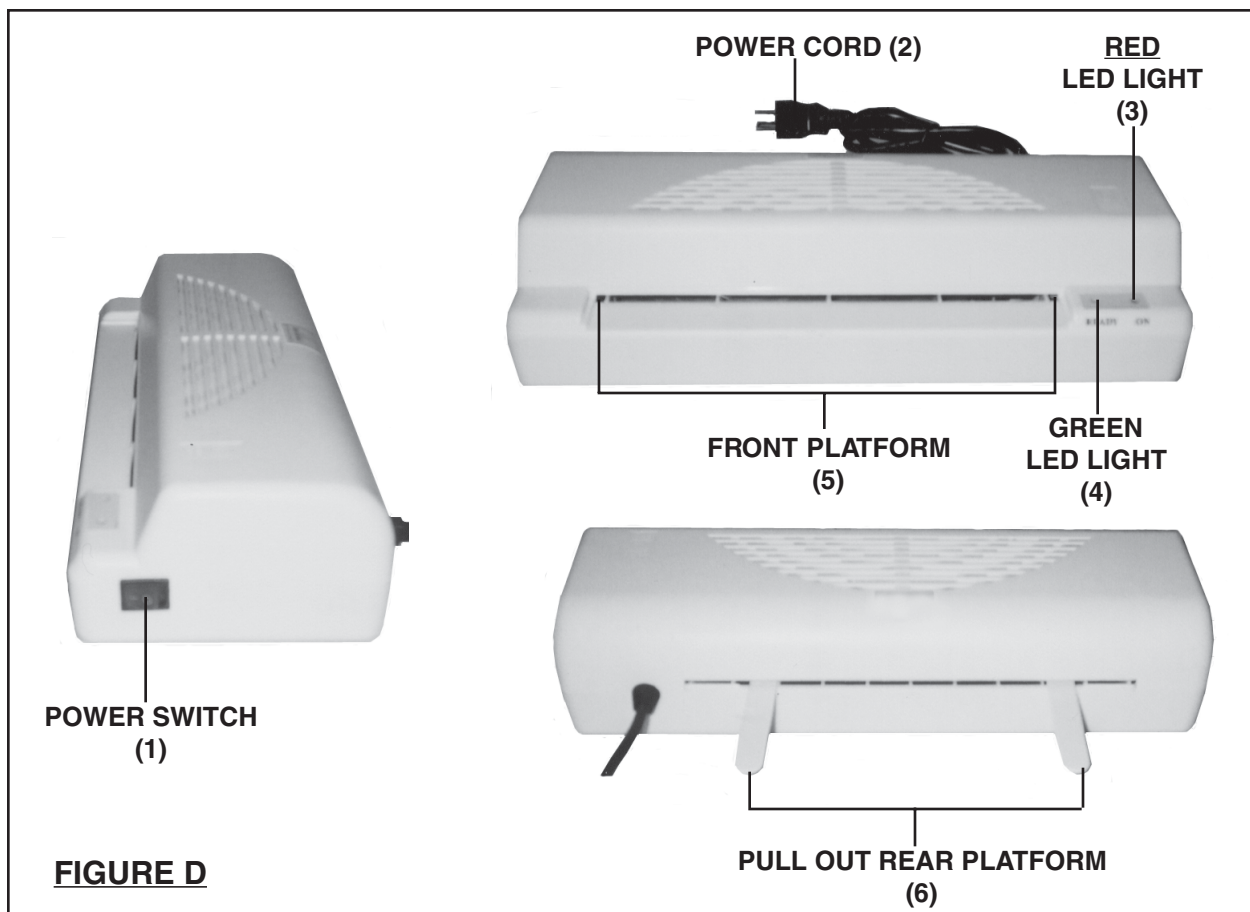

3. Turn the Power Switch (1) to its “ON” position. **NOTE:** The **Red** LED light (3) will illuminate, indicating that the electrical power is on. Also, the internal rollers will begin turning. **(See Figure D.)**
4. **IMPORTANT:** Prior to laminating, always allow **7** to **8** minutes for the Laminator to warm up *and* wait until the **Green** LED Light (4) illuminates, indicating the Laminator is “READY” to use. **(See Figure D.)**

5. Place the object to be laminated (i.e., paper, card, etc.) between the two layers of laminating film, and center the object on the laminating film.
6. Make sure the **sealed** edge of the laminating film is inserted first into the Laminator to avoid jamming. **Keep hands and fingers clear of the Adjustable Front Guide (6).**
7. Once inserted into the Laminator, the laminating object will be automatically drawn into the Laminator and ejected from the Rear Guide Platform (7). **To avoid possible accidental burns, make sure to wear safety gloves (not included) when first removing the laminating object from the Rear Guide Platform. (See Assy. Diagram.)**
8. When finished laminating, turn the Power Switch (1) to its “**OFF**” position and unplug the Laminator from its electrical outlet. Allow the Laminator to completely cool. Then store the unit in a dry, dust free location out of reach of children. **(See Figure D.)**

INSPECTION, MAINTENANCE, AND CLEANING

1.  **WARNING!** Make sure the Power Switch (1) of the Laminator is in its “**OFF**” position, the Power Cord (2) is unplugged from its electrical outlet, and the unit has completely cooled before performing any inspection, maintenance, or cleaning procedures.
2. **Before each use:** Inspect the general condition of the Laminator. Check for misalignment or binding of moving parts, damaged electrical wiring, cracked or broken parts, and any other condition that may affect its safe operation. If abnormal noise or vibration occurs, have the problem corrected before further use. **Do not use damaged equipment.**
3. **To clean:** Use a clean cloth and a mild detergent. Do not use solvents. Do not immerse any part of the Laminator in liquids.
4. **All maintenance, service, and repairs not listed in this manual are only to be attempted by a qualified technician.**

PLEASE READ THE FOLLOWING CAREFULLY

THE MANUFACTURER AND/OR DISTRIBUTOR HAS PROVIDED THE PARTS LIST AND ASSEMBLY DIAGRAM IN THIS MANUAL AS A REFERENCE TOOL ONLY. NEITHER THE MANUFACTURER OR DISTRIBUTOR MAKES ANY REPRESENTATION OR WARRANTY OF ANY KIND TO THE BUYER THAT HE OR SHE IS QUALIFIED TO MAKE ANY REPAIRS TO THE PRODUCT, OR THAT HE OR SHE IS QUALIFIED TO REPLACE ANY PARTS OF THE PRODUCT. IN FACT, THE MANUFACTURER AND/OR DISTRIBUTOR EXPRESSLY STATES THAT ALL REPAIRS AND PARTS REPLACEMENTS SHOULD BE UNDERTAKEN BY CERTIFIED AND LICENSED TECHNICIANS, AND NOT BY THE BUYER. THE BUYER ASSUMES ALL RISK AND LIABILITY ARISING OUT OF HIS OR HER REPAIRS TO THE ORIGINAL PRODUCT OR REPLACEMENT PARTS THERETO, OR ARISING OUT OF HIS OR HER INSTALLATION OF REPLACEMENT PARTS THERETO.

PARTS LIST AND ASSEMBLY DIAGRAM

| Part # | Description | Part # | Description |
|--------|---------------|--------|------------------------|
| 1 | Power Switch | 4 | Green LED Light |
| 2 | Power Cord | 5 | Front Platform |
| 3 | Red LED Light | 6 | Pull Out Rear Platform |

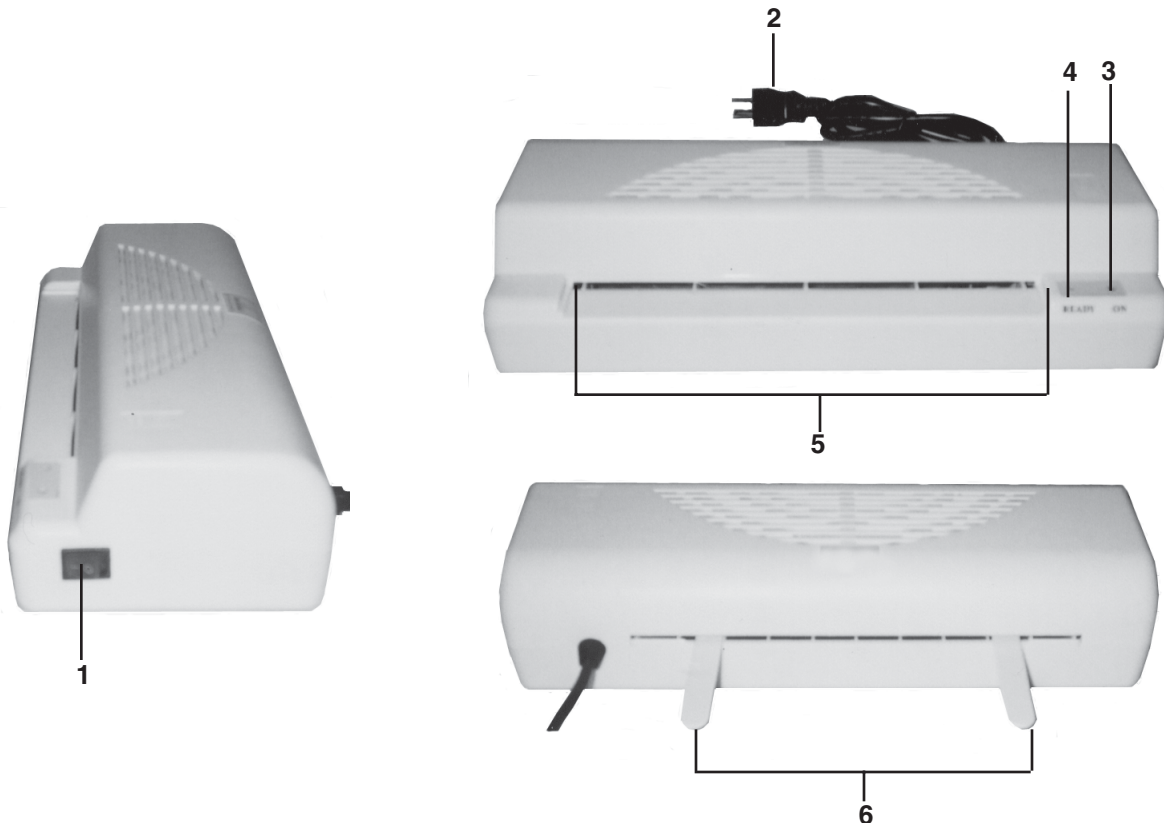

NOTE:

Some parts are shown for illustration purposes only, and are not available individually as replacement parts.